

INDOOR UNIT SERVICE MANUAL

No. OB454

**Wireless type
Models**

MSZ-GB50VA - E1

Outdoor unit service manual
MUZ-GB·VA series (OB455)
MXZ-A·VA series (OB377)
MXZ-8A140VA (OC316)

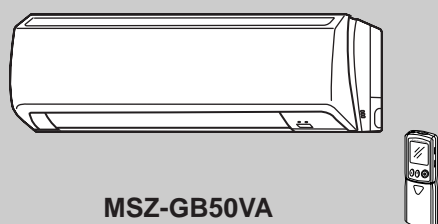

MSZ-GB50VA

CONTENTS

1. TECHNICAL CHANGES	2
2. PART NAMES AND FUNCTIONS.....	3
3. SPECIFICATION.....	5
4. NOISE CRITERIA CURVES	6
5. OUTLINES AND DIMENSIONS	7
6. WIRING DIAGRAM	8
7. REFRIGERANT SYSTEM DIAGRAM	8
8. SERVICE FUNCTIONS	9
9. TROUBLESHOOTING.....	10
10. DISASSEMBLY INSTRUCTIONS.....	24
11. RoHS PARTS LIST	27
12. OPTIONAL PARTS.....	30

NOTE:

- This service manual describes technical data of the indoor units.



MSZ-GA50VA -^[E1] → MSZ-GB50VA -^[E1]

Indoor unit size has been changed. (W1,100 mm x H325 mm x D258 mm → W780 mm x H298 mm x D210 mm)

2

PART NAMES AND FUNCTIONS

INDOOR UNIT

MSZ-GB50VA

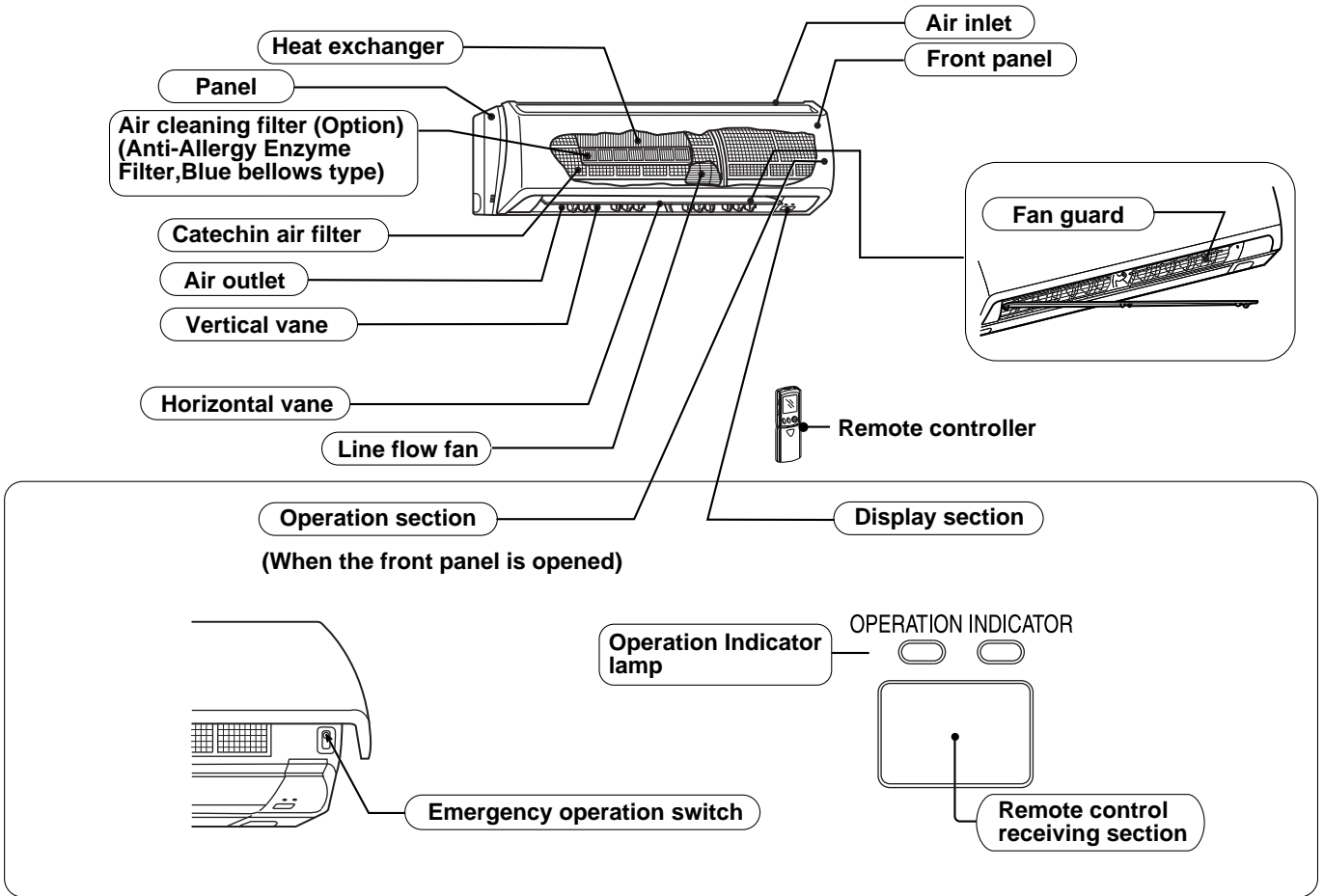

MSZ-GB50VA

ACCESSORIES

①	Installation plate	1
②	Installation plate fixing screw 4 × 25 mm	5
③	Remote controller holder	1
④	Fixing screw for ③ 3.5 × 1.6 mm (Black)	2
⑤	Battery (AAA) for remote controller	2
⑥	Wireless remote controller	1
⑦	Felt tape (Used for left or left-rear piping)	1

REMOTE CONTROLLER

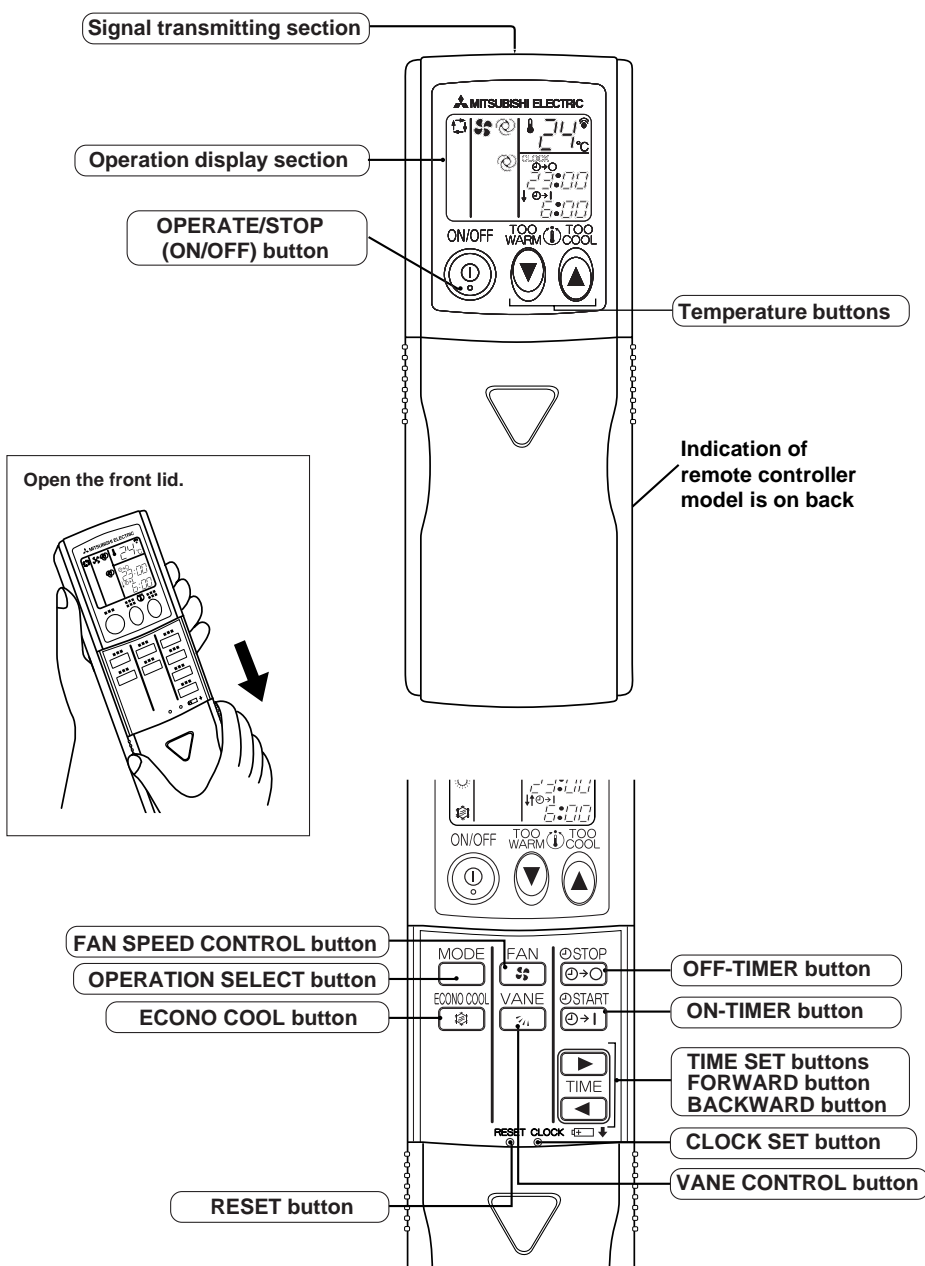

3

SPECIFICATION

Indoor model			MSZ-GB50VA	
Function			Cooling	Heating
Power supply			Single phase 230V,50Hz	
Capacity	Air flow(Super High)	m ³ /h	684	
	Air flow(High/Med./Low)	m ³ /h	654/445/414	
Electrical data	Power outlet	A	20	
	Running current *1	A	0.35	
	Power input *1	W	40	
	Power factor *1	%	50	
	Fan motor current *1	A	0.35	
Fan motor	Model	RC0J30-CC		
	Dimensions W×H×D	mm	780×298×210	
	Weight	kg	9	
Special remarks	Air direction		4	
	Sound level(Super High/High/Med./Low)	dB(A)	48/44/38/32	48/42/36/30
	Fan speed(Super High)	rpm	1,300	
	Fan speed(High/Med./Low)	rpm	1,200/1,100/900	
	Fan speed regulator		4	
	Remote controller model	KM05B		

NOTE : Test conditions are based on ISO 5151.

Cooling : Indoor Dry-bulb temperature 27°C Wet-bulb temperature 19°C

Outdoor Dry-bulb temperature 35°C Wet-bulb temperature 24°C

Heating : Indoor Dry-bulb temperature 20°C Wet-bulb temperature 15°C

Outdoor Dry-bulb temperature 7°C Wet-bulb temperature 6°C

Refrigerant piping length (one way): 5m

*1 Measured under rated operating frequency.

Specifications and rating conditions of main electric parts

INDOOR UNIT

Item		MSZ-GB50VA
Fuse	(F11)	T3.15AL 250V
Horizontal vane motor	(MV)	MSBPC20M16 12V DC 250Ω (at 25°C)
Varistor	(NR11)	ERZV14D471
Terminal block	(TB)	3P

5

OUTLINES AND DIMENSIONS

MSZ-GB50VA

Unit : mm

INDOOR UNIT

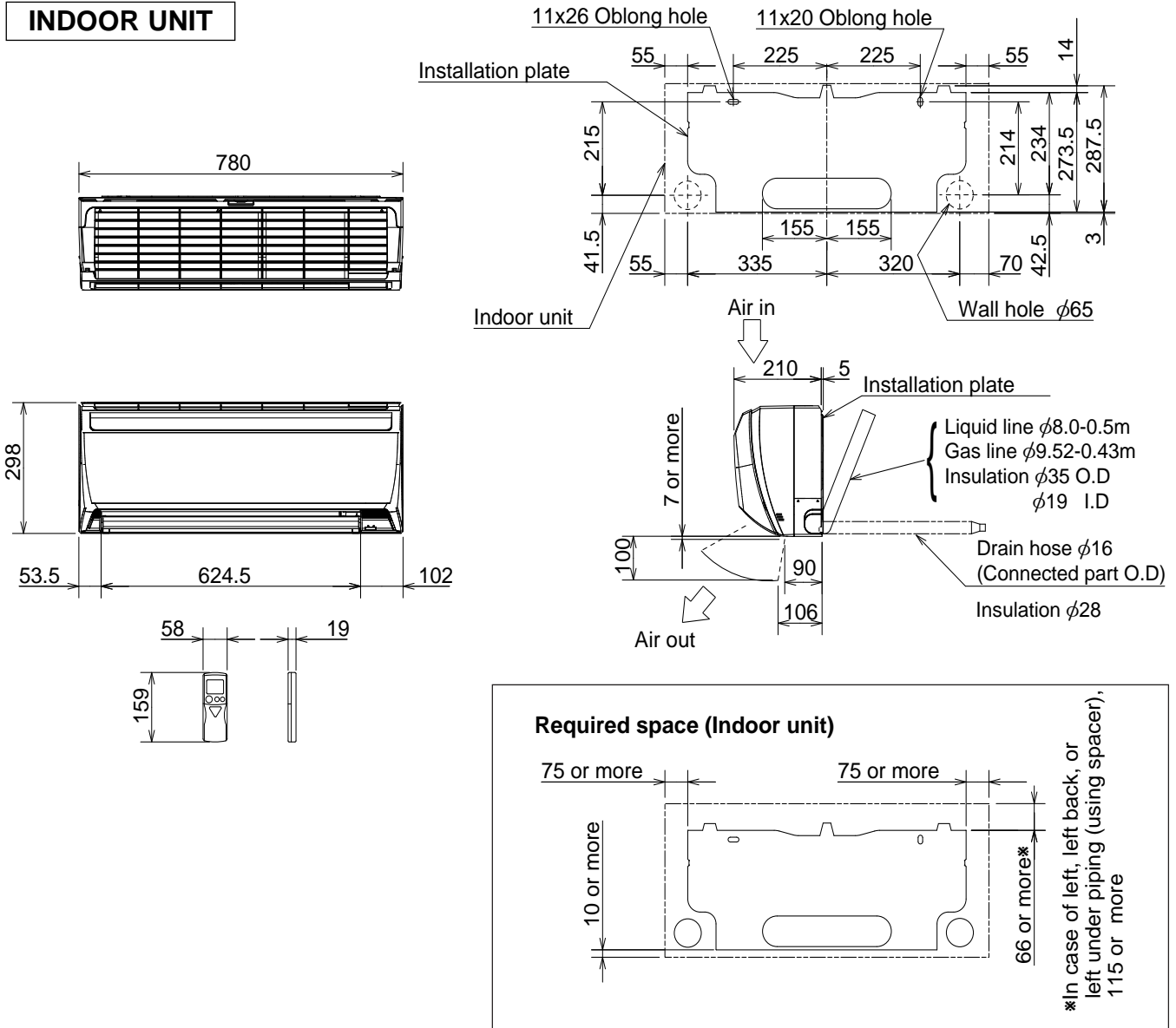

4

NOISE CRITERIA CURVES

MSZ-GB50VA

FAN SPEED	SPL(dB(A))	LINE
High	48	●—●

Test conditions,

Cooling : Dry-bulb temperature 27°C Wet-bulb temperature 19°C
 Heating : Dry-bulb temperature 20°C Wet-bulb temperature 15°C

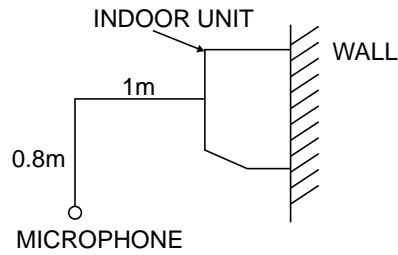
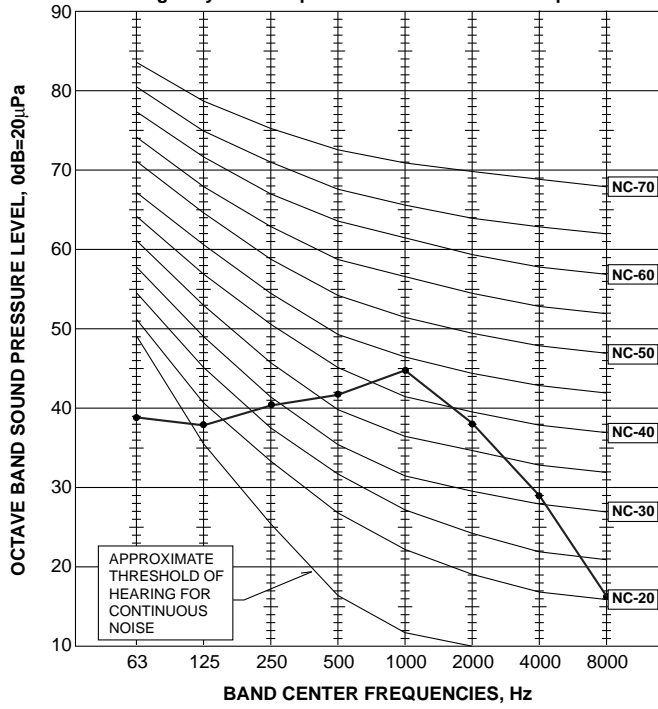

6

WIRING DIAGRAM

MSZ-GB50VA

INDOOR UNIT

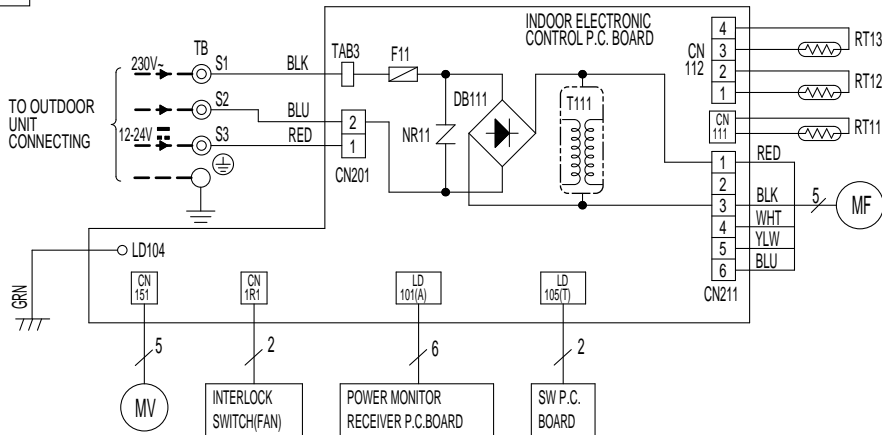

SYMBOL	NAME	SYMBOL	NAME
DB111	DIODE STACK	RT11	ROOM TEMPERATURE THERMISTOR
F11	FUSE (T3.15AL250V)	RT12	INDOOR COIL THERMISTOR (MAIN)
MF	INDOOR FAN MOTOR	RT13	INDOOR COIL THERMISTOR (SUB)
MV	VANE MOTOR (HORIZONTAL)	T111	TRANSFORMER
NR11	VARIATOR	TB	TERMINAL BLOCK

NOTE: 1. About the outdoor side electric wiring refer to the outdoor unit electric wiring diagram for servicing.
 2. Use copper conductors only. (For field wiring)
 3. Symbols below indicate.
 ◎: Terminal block, □□□□: Connector

7

REFRIGERANT SYSTEM DIAGRAM

MSZ-GB50VA

Unit : mm

INDOOR UNIT

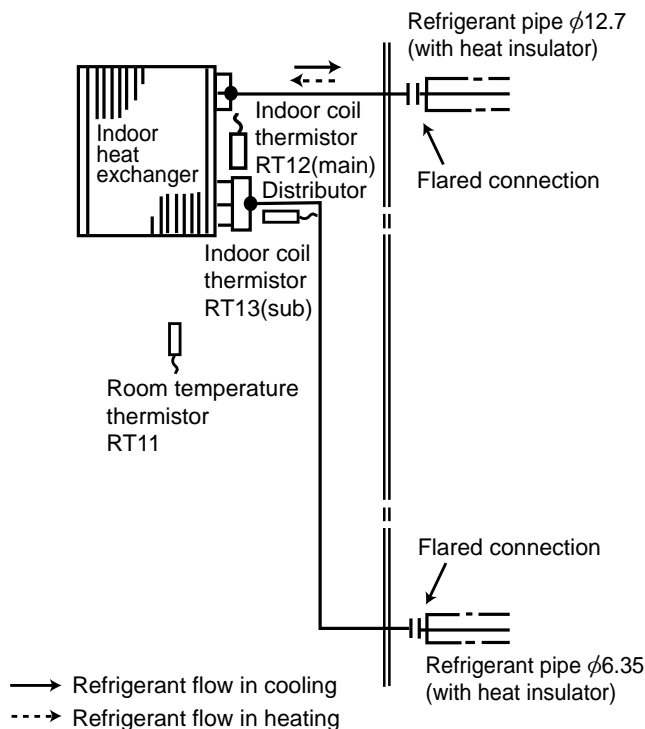

MSZ-GB50VA

8-1. TIMER SHORT MODE

For service, set time can be shortened by short circuit of JPG and JPS the electronic control P.C. board.

The time will be shortened as follows. (Refer to 9-7.)

Set time : 1-minute → 1-second

Set time : 3-minute → 3-second (It takes 3 minutes for the compressor to start operation. However, the starting time is shortened by short circuit of JPG and JPS.)

8-2. P.C. BOARD MODIFICATION FOR INDIVIDUAL OPERATION

A maximum of 4 indoor units with wireless remote controllers can be used in a room.

In this case, to operate each indoor unit individually by each remote controller, P.C. boards of remote controller must be modified according to the number of the indoor unit.

How to modify the remote controller P.C. board

Remove batteries before modification.

The board has a print as shown below :

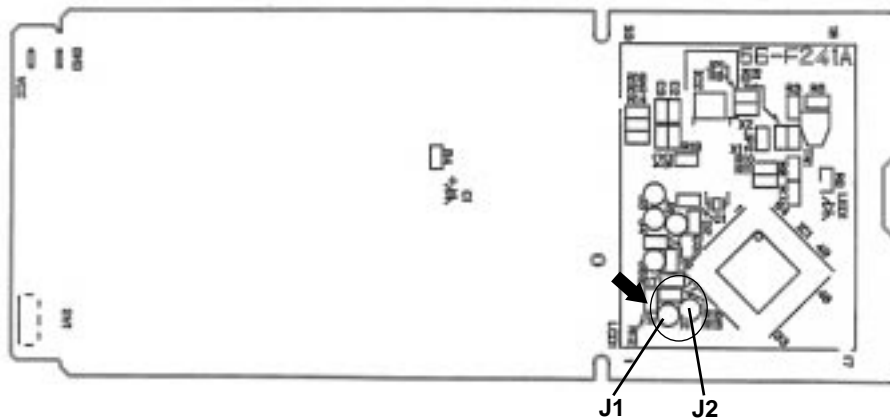

NOTE : For remodelling, take out the batteries and press the OPERATE/STOP(ON/OFF) button twice or 3 times at first.

After finish remodelling, put back the batteries then press the RESET button.

The P.C. board has the print "J1" and "J2". Solder "J1" and "J2" according to the number of indoor unit as shown in Table 1. After modification, press the RESET button.

Table 1

	1 unit operation	2 units operation	3 units operation	4 units operation
No. 1 unit	No modification	Same as at left	Same as at left	Same as at left
No. 2 unit	–	Solder J1	Same as at left	Same as at left
No. 3 unit	–	–	Solder J2	Same as at left
No. 4 unit	–	–	–	Solder both J1 and J2

How to set the remote controller exclusively for particular indoor unit.

After you turn the breaker ON, the first remote controller that sends the signal to the indoor unit will be regarded as the remote controller for the indoor unit.

The indoor unit will only accept the signal from the remote controller that has been assigned to the indoor unit once they are set.

The setting will be cancelled if the breaker has turned off, or the power supply has shut down.

Please conduct the above setting once again after the power has restored.

8-3. AUTO RESTART FUNCTION

When the indoor unit is controlled with the remote controller, the operation mode, the set temperature, and the fan speed are memorized by the indoor electronic control P.C. board. The "AUTO RESTART FUNCTION" sets to work the moment power has restored after power failure. Then, the unit will restart automatically.

Operation

- ① If the main power has been cut, the operation settings remain.
- ② After the power is restored, the unit restarts automatically according to the memory.

(However, it takes at least 3 minutes for the compressor to start running.)

How to release "AUTO RESTART FUNCTION"

- ① Turn off the main power for the unit.
- ② Solder the Jumper wire JR07 on the indoor electronic control P.C. board. (Refer to 9-7.)

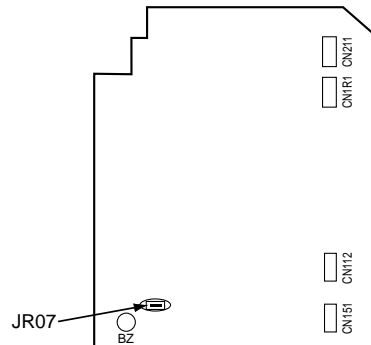

NOTE:

- The operation settings are memorized when 10 seconds have passed after the indoor unit was operated with the remote controller.
- If main power is turned OFF or a power failure occurs while AUTO START/STOP timer is active, the timer setting is cancelled.
- If the unit has been off with the remote controller before power failure, the auto restart function does not work as the power button of the remote controller is off.
- To prevent breaker off due to the rush of starting current, systematize other home appliance not to turn on at the same time.
- When some air conditioners are connected to the same supply system, if they are operated before power failure, the starting current of all the compressors may flow simultaneously at restart. Therefore, the special counter-measures are required to prevent the main voltage-drop or the rush of the starting current by adding to the system that allows the units to start one by one.

9

TROUBLESHOOTING

MSZ-GB50VA

9-1. Cautions on troubleshooting

1. Before troubleshooting, check the following:

- 1) Check the power supply voltage.
- 2) Check the indoor/outdoor connecting wire for mis-wiring.

2. Take care the following during servicing.

- 1) Before servicing the air conditioner, be sure to turn off the unit first with the remote controller, and then after confirming the horizontal vane is closed, turn off the breaker and / or disconnect the power plug.
- 2) Be sure to turn OFF the power supply before removing the front panel, the cabinet, the top panel, and the electronic control P.C. board.
- 3) When removing the electronic control P.C. board, hold the edge of the board with care NOT to apply stress on the components.
- 4) When connecting or disconnecting the connectors, hold the housing of the connector. DO NOT pull the lead wires.

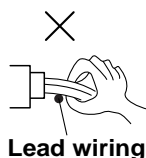

3. Troubleshooting procedure

- 1) First, check if the OPERATION INDICATOR lamp on the indoor unit is flashing on and off to indicate an abnormality. To make sure, check how many times the abnormality indication is flashing on and off before starting service work.
- 2) Before servicing check that the connector and terminal are connected properly.
- 3) If the electronic control P.C. board is supposed to be defective, check the copper foil pattern for disconnection and the components for bursting and discoloration.
- 4) When troubleshooting, refer to 9-2., 9-3. and 9-4.

4. How to replace batteries

Weak batteries may cause the remote controller malfunction.

In this case, replace the batteries to operate the remote controller normally.

- ① Remove the front lid and insert batteries. Then reattach the front lid.

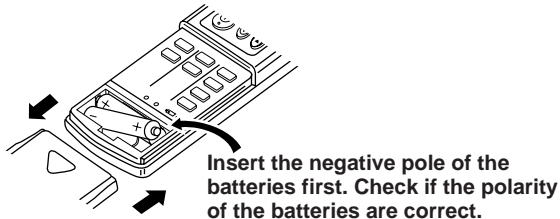

- ② Press RESET button with tip end of ball point pen or the like, and then use the remote controller.

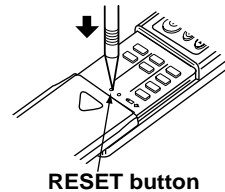

- NOTE :**
1. If RESET button is not pressed, the remote controller may not operate correctly.
 2. This remote controller has a circuit to automatically reset the microcomputer when batteries are replaced. This function is equipped to prevent the microcomputer from malfunctioning due to the voltage drop caused by the battery replacement.

5. How to install the horizontal vane

If horizontal vane is not installed correctly, all of the operation indicator lamps will blink.

In this case, install the horizontal vane correctly by following the procedures ① to ②.

NOTE: Before installation of the horizontal vane, turn OFF the power supply.

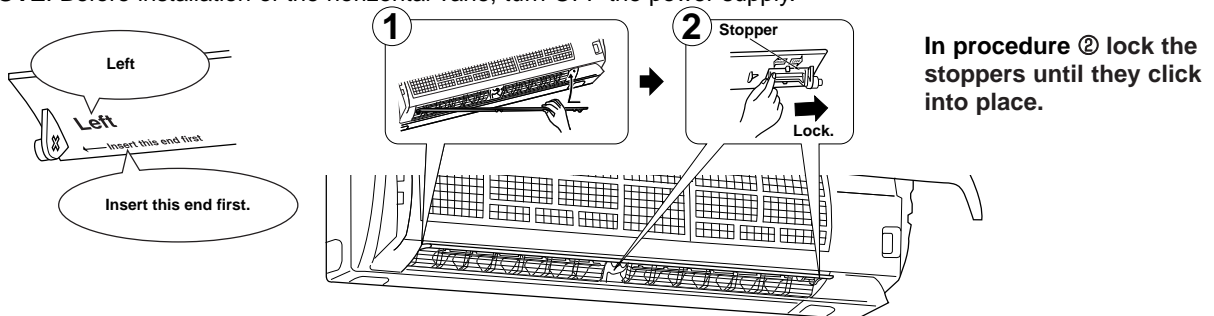

INFORMATION FOR MULTI SYSTEM AIR CONDITIONER

OUTDOOR UNIT : MXZ series

Multi system air conditioner can connect two or more indoor units with one outdoor unit.

- Unit won't operate in case the total capacity of indoor units exceeds the capacity of outdoor units. Do not connect indoor units beyond the outdoor unit capacity.

Operation indicator lamp flashes as shown in the figure below.

- When you try to operate two or more indoor units with one outdoor unit simultaneously, one for the cooling and the other for heating, the operation mode of the indoor unit that operates earlier is selected. The other indoor units will start the operation later cannot operate, indicating as shown in the figure below. In this case, please set all the indoor units to the same operation mode.

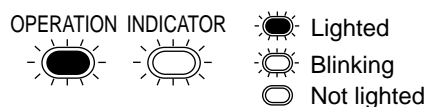

- When indoor units starts the operation while the defrosting of outdoor unit is being done, it takes a few minutes (max. 10 minutes) to blow out the warm air.
- In the heating operation, though indoor unit that does not operate may get warm or the sound of refrigerant flowing may be heard, they are not malfunction. The reason is that the refrigerant continuously flows into it.

9-2. Failure mode recall function

Outline of the function

This air conditioner can memorize the abnormal condition which has occurred once.

Even though LED indication listed on the troubleshooting check table (9-4.) disappears, the memorized failure details can be recalled.

This mode is very useful when the unit needs to be repaired for the abnormality which doesn't recur.

1. Flow chart of failure mode recall function for the indoor/outdoor unit

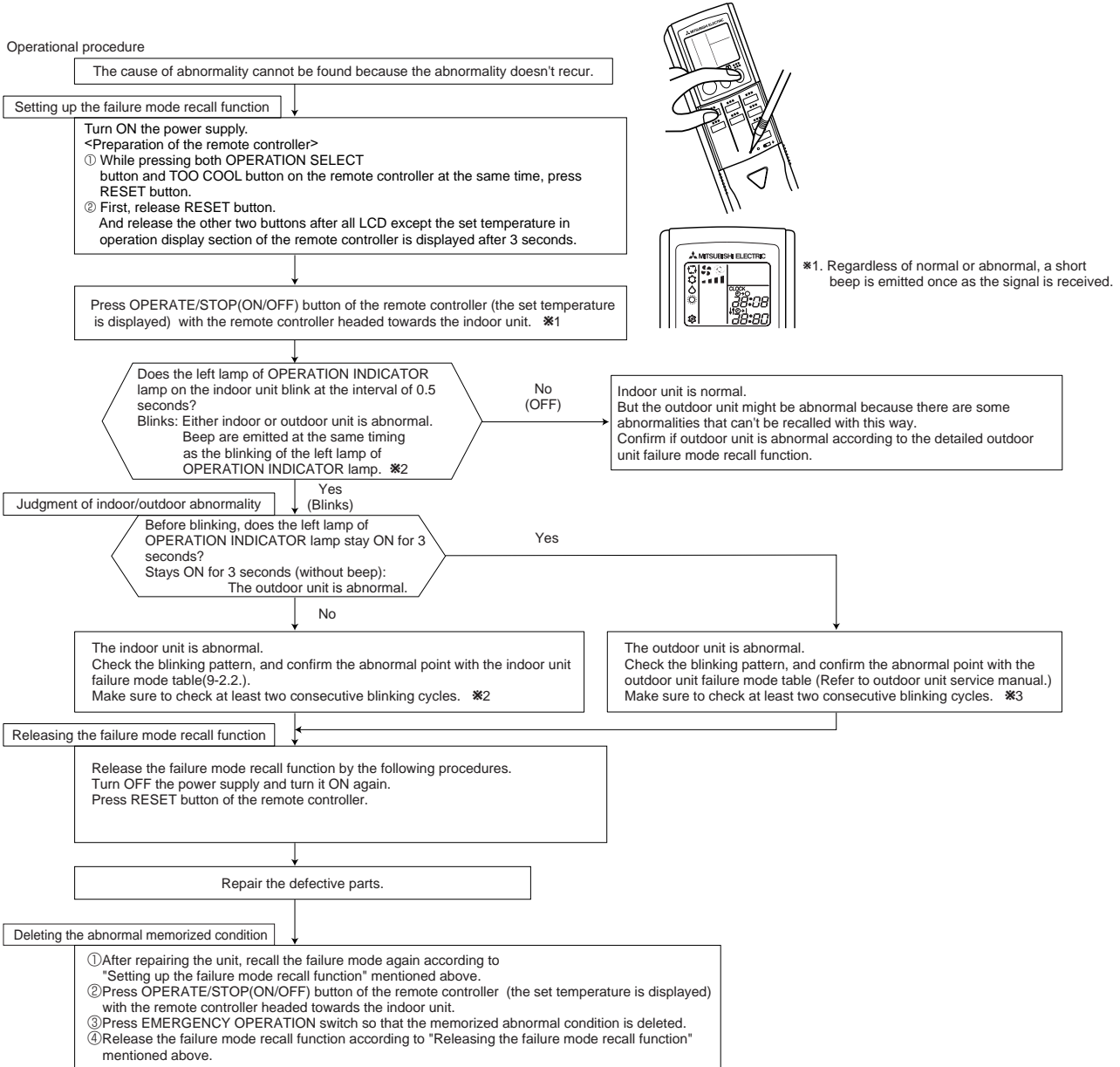

Note1. Make sure to release the failure mode recall function once it's set up, otherwise the unit cannot operate properly.

2. If the abnormal condition is not deleted from the memory, the last abnormal condition is kept memorized.

※2. Blinking pattern when the indoor unit is abnormal:

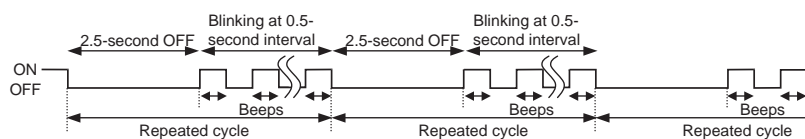

※3. Blinking pattern when the outdoor unit is abnormal:

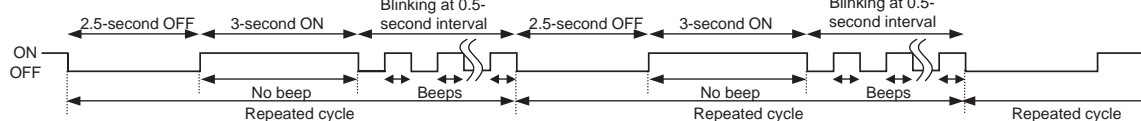

2. Indoor unit failure mode table

Left lamp of OPERATION INDICATOR lamp	Abnormal point (Failure mode)	Condition	Correspondence
Not lighted	Normal	–	–
1-time flash every 0.5-second	Room temperature thermistor	When the room temperature thermistor short or open circuit is detected every 8 seconds during operation.	Refer to the characteristics of the room temperature thermistor (9-7.).
2-time flash 2.5-second OFF	Indoor coil thermistor	When the indoor coil thermistor short or open circuit is detected every 8 seconds during operation.	Refer to the characteristics of the main indoor coil thermistor, the sub indoor coil thermistor (9-7.).
3-time flash 2.5-second OFF	Serial signal	When the serial signal from outdoor unit is not received for a maximum of 6 minutes.	Refer to 9-6.Ⓒ "How to check mis-wiring and serial signal error".
11-time flash 2.5-second OFF	Indoor fan motor	When the rotational frequency feedback signal is not emit during the 12-seconds the indoor fan operation.	Refer to 9-6.Ⓐ "Check of indoor fan motor".
12-time flash 2.5-second OFF	Indoor control system	When it cannot properly read data in the nonvolatile memory of the indoor electronic control P.C. board.	Replace the indoor electronic control P.C. board.

NOTE : Blinking patterns of this mode differ from the ones of Troubleshooting check table(9-4.).

9-3. Instruction of troubleshooting

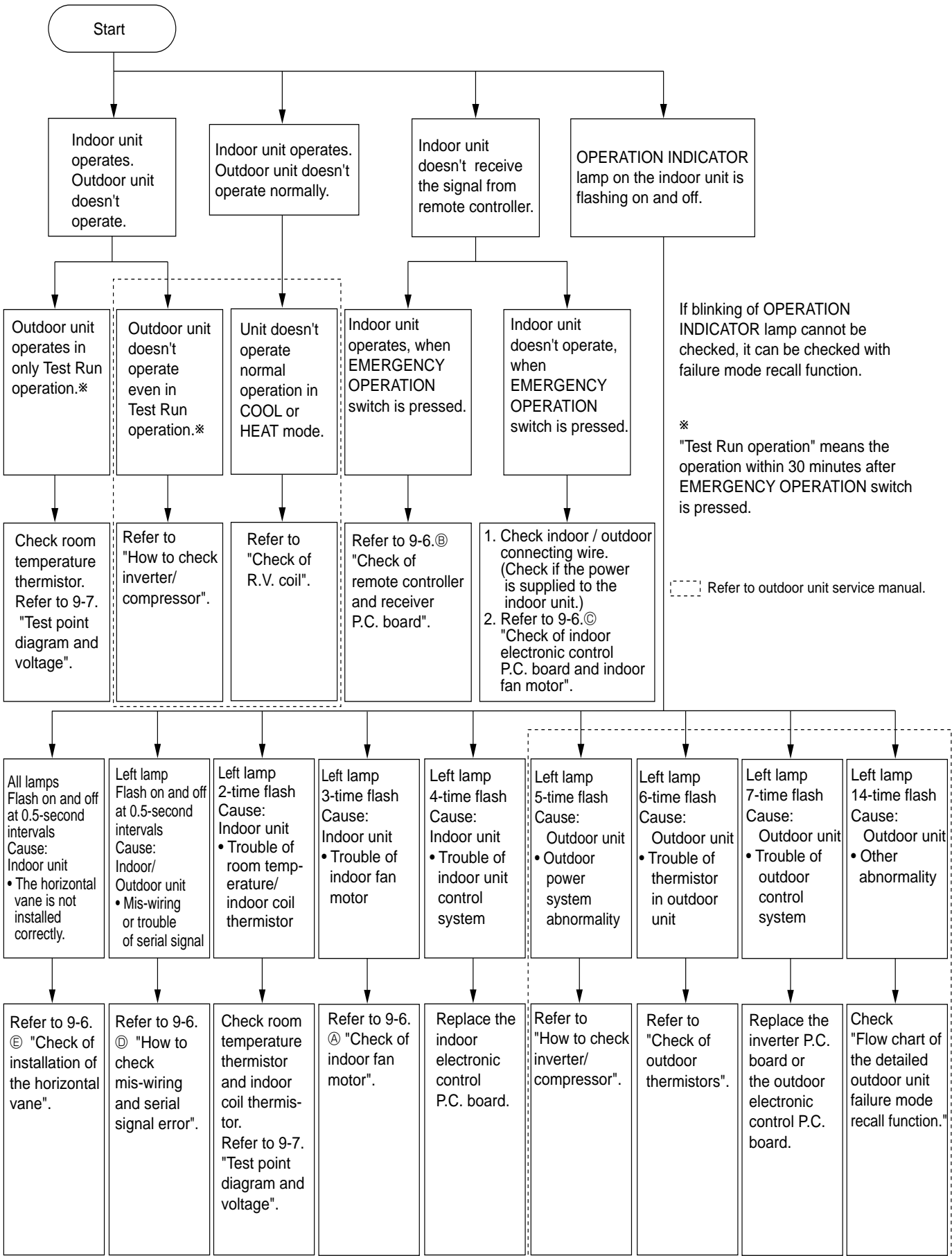

9-4. Troubleshooting check table

Before taking measures, make sure that the symptom reappears for accurate troubleshooting. When the indoor unit has started operation and the following detection method has detected an abnormality (the first detection after the power ON), the indoor electronic control P.C. board turns OFF the indoor fan motor with OPERATION INDICATOR lamp flashing.

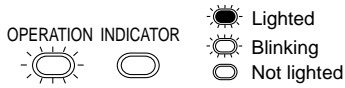

· Flashing of OPERATION INDICATOR lamp (left-hand side lamp) indicates abnormalities.

No.	Abnormal point	Operation indicator lamp	Symptom	Condition	Correspondence
1	Mis-Wiring or serial signal	Left lamp flashes. 0.5-second ON ●○●○●○●○ 0.5-second OFF	Indoor unit and outdoor unit do not operate.	When the serial signal from the outdoor unit is not received for a maximum of 6 minutes.	• Refer to 9-6.① "How to check mis-wiring and serial signal error".
2	Outdoor control system	Left lamp lights up ●	Outdoor unit does not operate.	When it cannot properly read data in the nonvolatile memory of the inverter P.C. board or the outdoor electronic control P.C. board.	• Check the blinking pattern of the LED on the inverter P.C. board or the outdoor electronic control P.C. board.
3	Indoor coil thermistor Room temperature thermistor	Left lamp flashes. 2-time flash ●●○○○○●●○○ 2.5-second OFF	Indoor unit and outdoor unit do not operate.	When the indoor coil or the room temperature thermistor is short or open circuit.	• Refer to 9-7.the characteristics of indoor coil thermistor, and the room temperature thermistor.
4	Indoor fan motor	Left lamp flashes. 3-time flash ●●●○○○○●●●○○○○ 2.5-second OFF	Indoor unit and outdoor unit do not operate.	When the rotational frequency feedback signal is not emitted during the indoor fan operation.	• Refer to 9-6.④ "Check of indoor fan motor".
5	Indoor control system	Left lamp flashes. 4-time flash ●●●●○○○○●●●●●● 2.5-second OFF	Indoor unit and outdoor unit do not operate.	When it cannot properly read data in the nonvolatile memory of the indoor electronic control P.C. board.	• Replace the indoor electronic control P.C. board.
6	Outdoor power system	Left lamp flashes. 5-time flash ●●●●●○○○○●●●● 2.5-second OFF	Indoor unit and outdoor unit do not operate.	When it consecutively occurs 3 times that the compressor stops for overcurrent protection or start-up failure protection within 1 minute after start-up.	• Refer to "How to check inverter/compressor". Refer to outdoor unit service manual. • Check the stop valve.
7	Outdoor thermistors	Left lamp flashes. 6-time flash ●●●●●●○○○○●●●● 2.5-second OFF	Indoor unit and outdoor unit do not operate.	When the outdoor thermistors short or open circuit during the compressor operation.	• Refer to "Check of outdoor thermistor". Refer to outdoor unit service manual.
8	Outdoor control system	Left lamp flashes. 7-time flash ●●●●●●●○○○○●●●● 2.5-second OFF	Indoor unit and outdoor unit do not operate.	When it cannot properly read data in the nonvolatile memory of the inverter P.C. board or the outdoor electronic control P.C. board.	• Replace the inverter P.C. board or the outdoor electronic control P.C. board. Refer to outdoor unit service manual.
9	Other abnormality	Left lamp flashes. 14-time flash ●●●●●●●●○○○○●●●●●●●● 2.5-second OFF	Indoor unit and outdoor unit do not operate.	An abnormality other than above mentioned is detected.	• Confirm the abnormality in detail using the failure mode recall function for outdoor unit.

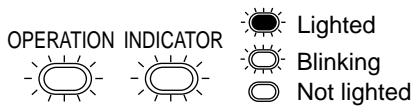

· Flashing of OPERATION INDICATOR lamp (all lamps) indicates abnormality.

No.	Abnormal point	Operation indicator lamp	Symptom	Condition	Correspondence
1	Attachment of the horizontal vane	All lamps flash at the same time. 0.5-second ON 0.5-second OFF	Indoor unit and outdoor unit do not operate.	When the electricity is not conducted to the interlock switch (Fan) of the horizontal vane.	• Refer to 9-6.Ⓔ "Check of installation of the horizontal vane".

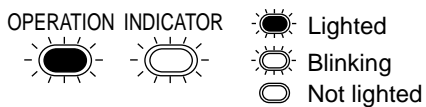

· Flashing of OPERATION INDICATOR lamp (right-hand side lamp) indicates abnormality.

· OPERATION INDICATOR lamp (left-hand side lamp) is lighted.

No.	Abnormal point	Operation indicator lamp	Symptom	Condition	Correspondence
1	MXZ type Operation mode setting	Right lamp flash 2.5-second OFF	Outdoor unit operates but indoor unit does not operate.	When the operation mode of the each indoor unit is differently set to COOL (includes DRY) and HEAT at the same time, the operation mode of the indoor unit that has operated at first has the priority.	• Unify the operation mode. Refer to outdoor unit service manual.

9-5. Trouble criterion of main parts

MSZ-GB50VA

Part name	Check method and criterion	Figure		
Room temperature thermistor (RT11)	Measure the resistance with a tester.	/		
Indoor coil thermistor (RT12(MAIN), RT13(SUB))	Refer to 9-7. "Test point diagram and voltage", "Indoor electronic control P.C. board", the chart of thermistor.			
Indoor fan motor (MF)	Check 9-6. Ⓐ.	/		
Horizontal vane motor (MV)	Measure the resistance between the terminals with a tester. (Part temperature 10°C ~ 30°C)			
	<table border="1"> <tr> <td>Color of the lead wire</td> <td>Normal</td> </tr> <tr> <td>BRN-other one</td> <td>235 Ω ~ 255 Ω</td> </tr> </table>		Color of the lead wire	Normal
Color of the lead wire	Normal			
BRN-other one	235 Ω ~ 255 Ω			

9-6. Troubleshooting flow

When OPERATION INDICATOR lamp flashes 3-time.
Indoor fan does not operate.

A Check of indoor fan motor

The indoor fan motor error has occurred, and the indoor fan doesn't operate.

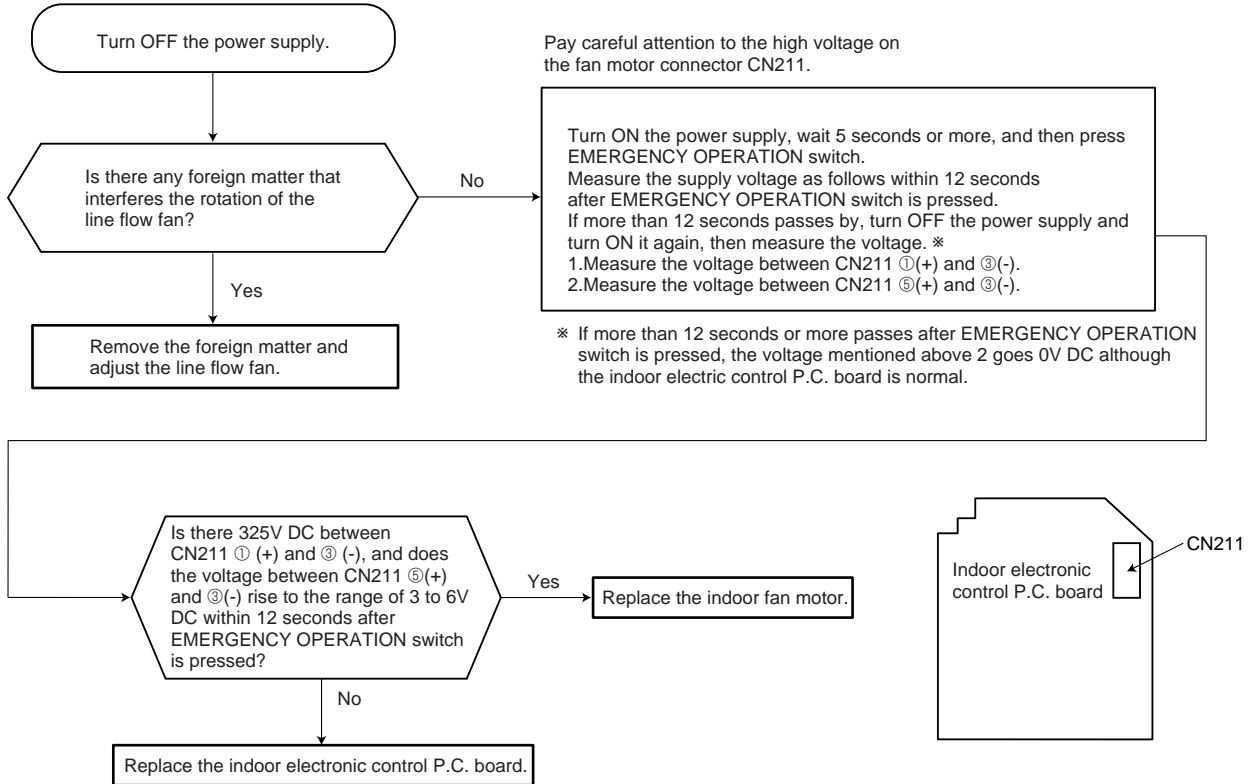

The indoor fan motor error has occurred, and the indoor fan repeats "12-second ON and 30-second OFF" 3times, and then stops.

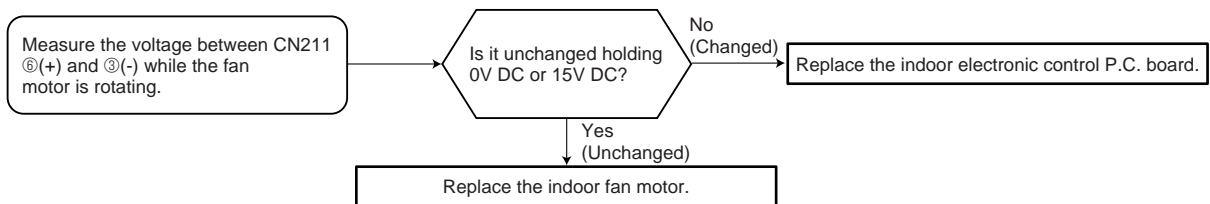

Indoor unit operates by pressing EMERGENCY OPERATION switch, but does not operate with the remote controller.

Ⓑ Check of remote controller and receiver P.C. board

*Check if the remote controller is exclusive for this air conditioner.

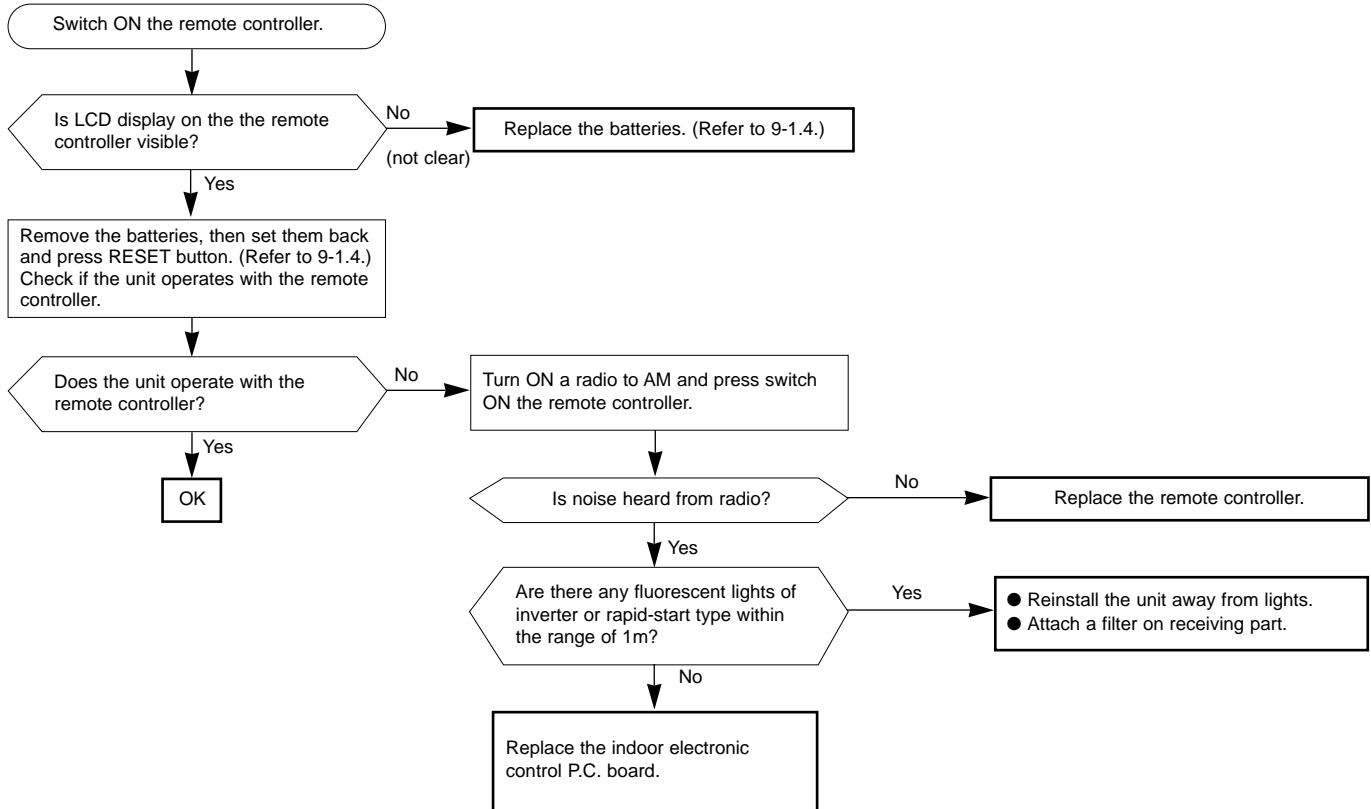

The unit does not operate with the remote controller.
 Also, OPERATION INDICATOR lamp does not light up by pressing EMERGENCY OPERATION switch.

© Check of indoor electronic control P.C. board and indoor fan motor

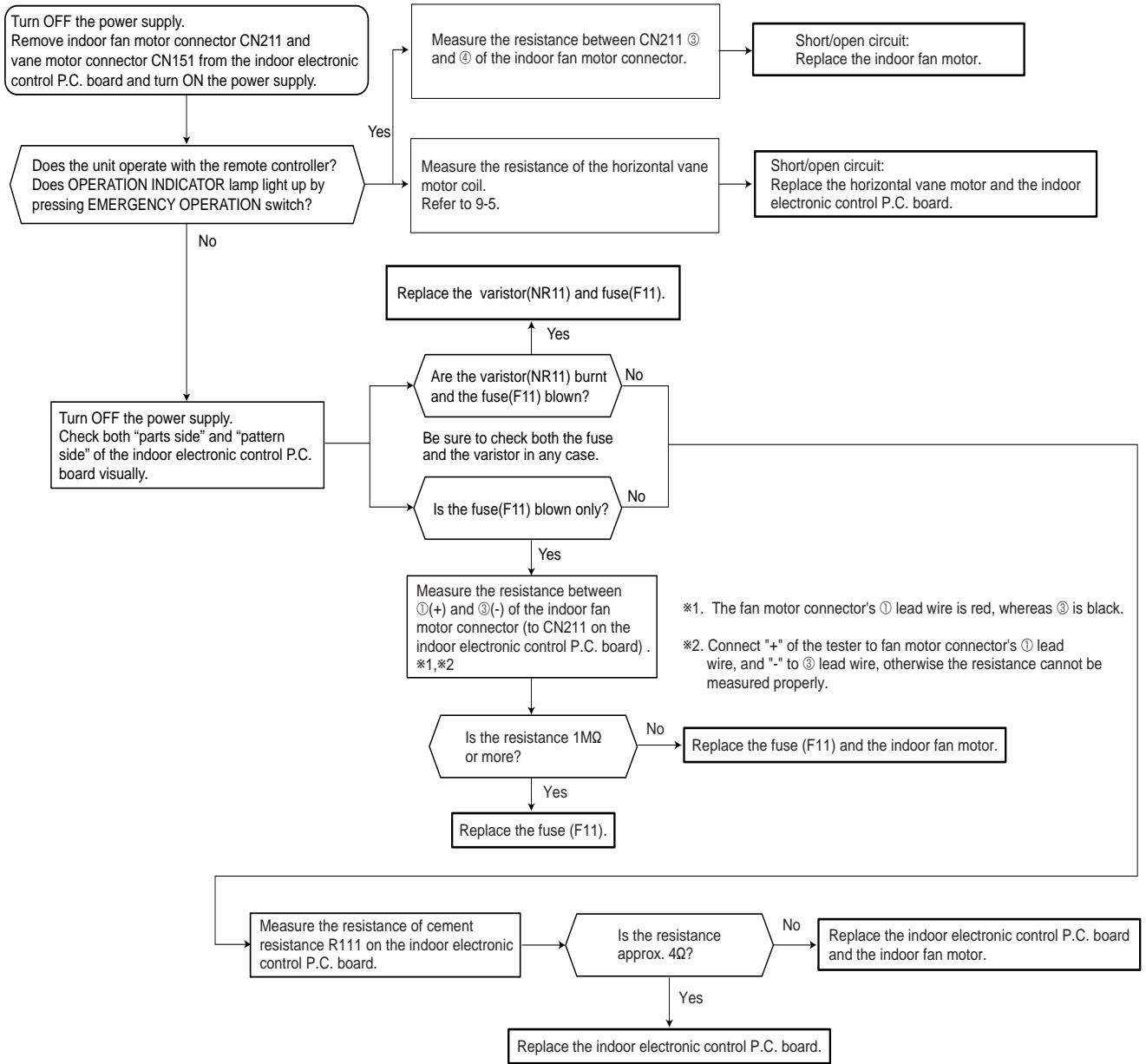

Indoor electronic control P.C.Board

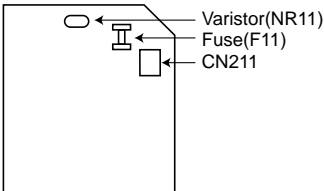

- When unit cannot operate neither by the remote controller nor by EMERGENCY OPERATION switch. Indoor unit does not operate.
- When OPERATION INDICATOR lamp flashes ON and OFF in every 0.5-second. Outdoor unit does not operate.

④ How to check mis-wiring and serial signal error (when outdoor unit does not work)

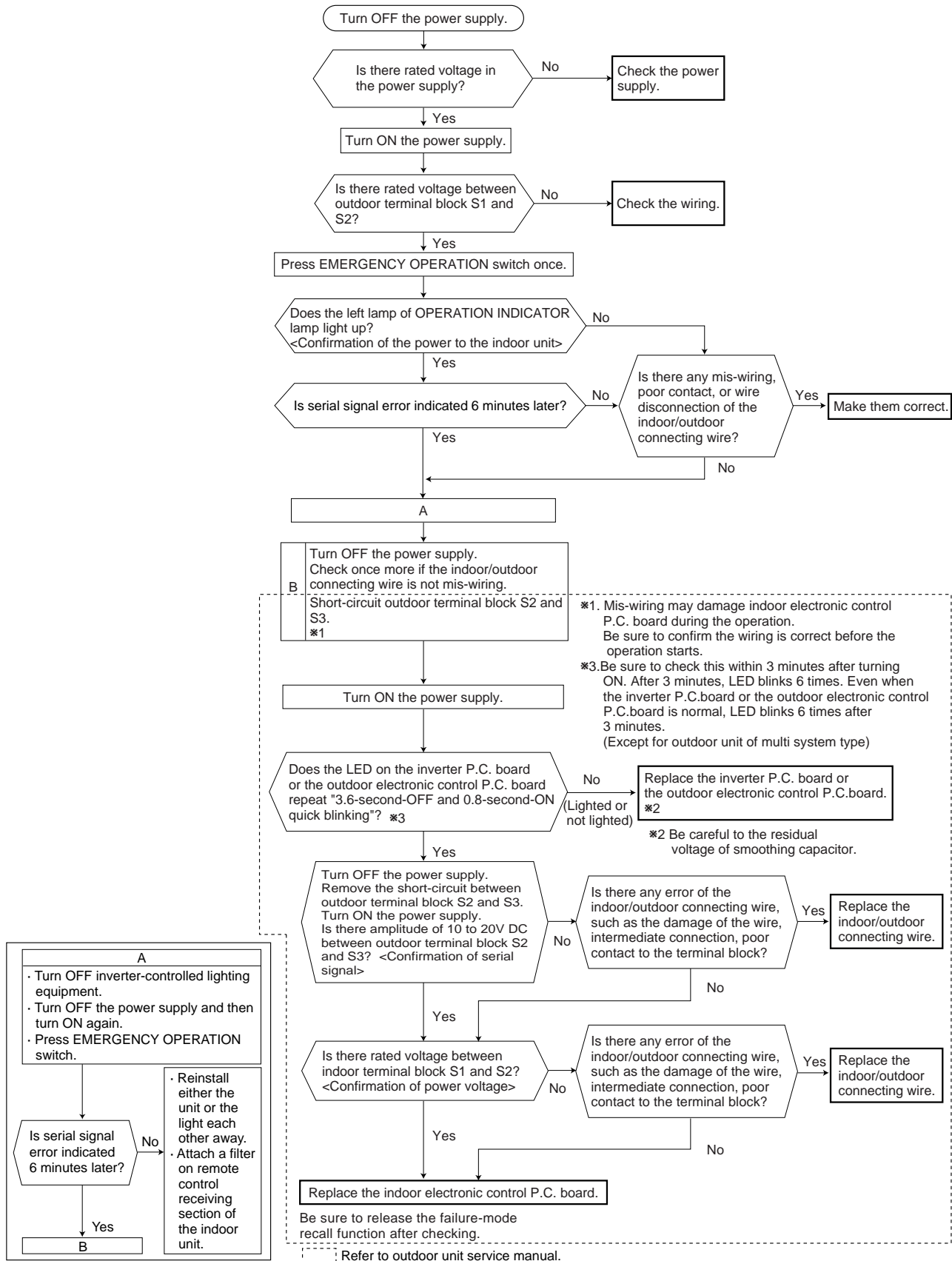

When All lamps flash ON and OFF every 0.5-second.
Indoor unit and outdoor unit do not operate.

E Check of installation of the horizontal vane

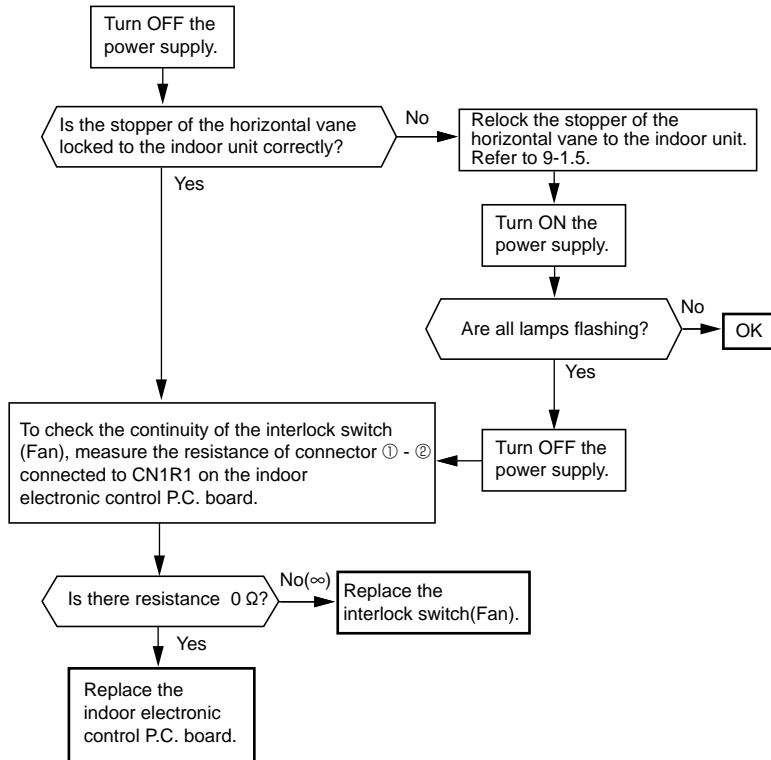

F Electromagnetic noise enters into TV sets or radios

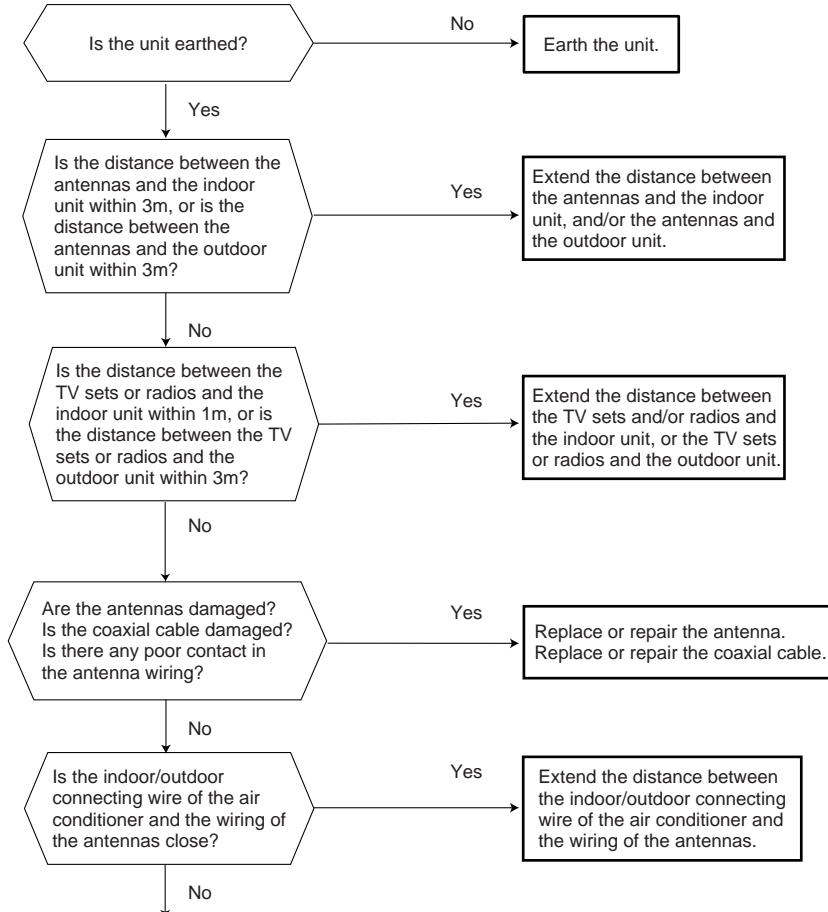

Even if all of the above conditions is fulfilled, the electromagnetic noise may enter, depending on the electric field strength or the installation condition (combination of specific conditions such as antennas or wiring).
Check the followings before asking for service.

- 1.Devices affected by the electromagnetic noise
TV sets, radios (FM/AM broadcast, shortwave)
- 2.Channel, frequency, broadcast station affected by the electromagnetic noise
- 3.Channel, frequency, broadcast station unaffected by the electromagnetic noise
- 4.Layout of ;
indoor/outdoor unit of the air conditioner, indoor/outdoor wiring, grounding wire, antennas, wiring from antennas, receiver
- 5.Electric field intensity of the broadcast station affected by the electromagnetic noise
- 6.Presence or absence of amplifier such as booster
- 7.Operation condition of air conditioner when the electromagnetic noise enters in.
 - 1)Turn OFF the power supply once, and then turn ON the power supply. In this situation check for the electromagnetic noise.
 - 2)Within 3 minutes after turning ON the power supply, press OPERATE/STOP (ON/OFF) button on the remote controller for power ON, and check for the electromagnetic noise.
 - 3)After a short time (3 minutes later after turning ON), the outdoor unit starts running. During operation, check for the electromagnetic noise.
 - 4)Press OPERATE/STOP (ON/OFF) button on the remote controller for power OFF, when the outdoor unit stops but the indoor/outdoor communication still runs on. In this situation check for the electromagnetic noise.

After checking the above, consult the service representative.

9-7. Test point diagram and voltage
MSZ-GB50VA
Indoor electronic control P.C. board

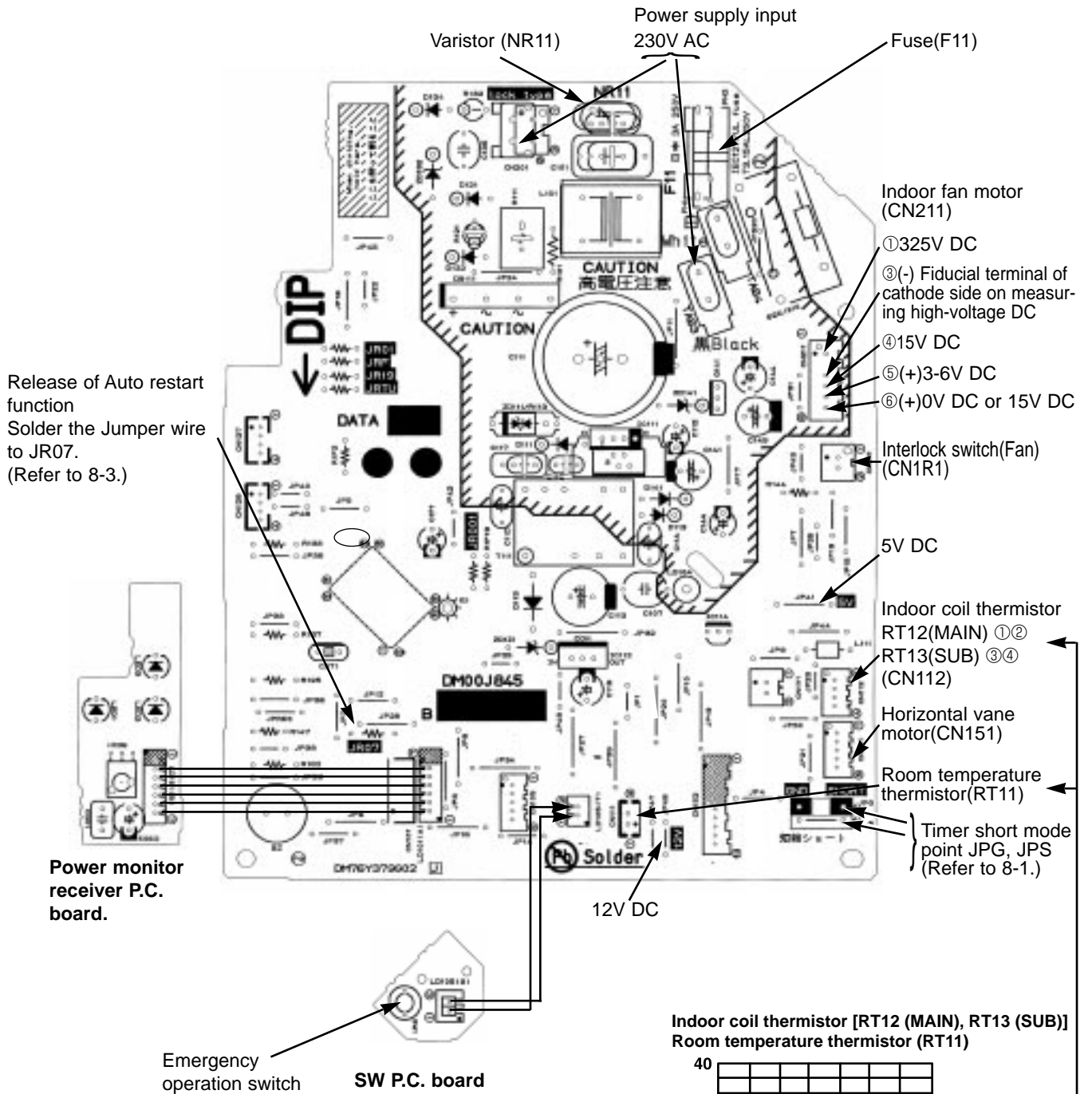

Indoor coil thermistor [RT12 (MAIN), RT13 (SUB)]
 Room temperature thermistor (RT11)

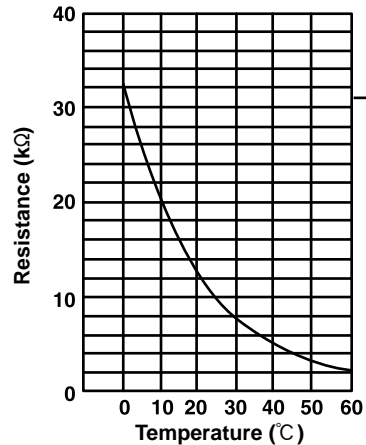

<"Terminal with locking mechanism" Detaching points>

The terminal which has the locking mechanism can be detached as shown below.
There are two types (Refer to (1) and (2)) of the terminal with locking mechanism.
The terminal without locking mechanism can be detached by pulling it out.
Check the shape of the terminal before detaching.

(1) Slide the sleeve and check if there is a locking lever or not.

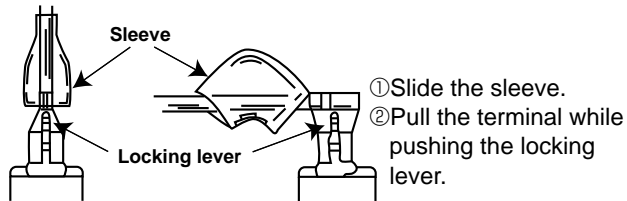

(2) The terminal with this connector has the locking mechanism.

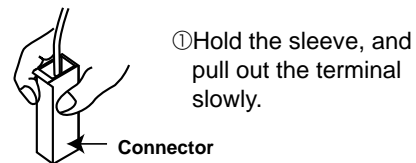
**MSZ-GB50VA
INDOOR UNIT**

OPERATING PROCEDURE	PHOTOS
<p>1. Removing the panel</p> <p>(1) Remove the horizontal vane. (2) Remove the screw caps of the panel. Remove the screws. (See Photo 1.) (3) Hold the lower part of both ends on the panel and pull it slightly toward you, and then remove the panel by pushing it upward.</p>	<p>Photo 1</p> <p>Horizontal vane</p> <p>Screws of the panel</p>



OPERATING PROCEDURE

2. Removing the electronic control P.C. board, the power monitor receiver P.C. board, SW P.C. board and the terminal block

- (1) Remove the horizontal vane, the panel (Refer to 1.) and the corner box.
- (2) Remove the screw of V.A. clamp, and then the indoor/outdoor connecting wire. (See Photo 2.)
- (3) Remove the switch holder from the electrical cover. (See Photo 3.)
- (4) Remove the screw of the electrical cover, and then the electrical cover. (See Photo 3.)
- (5) Remove the ground wire connected to the indoor electronic control P.C. board from the electrical box. (See Photo 4.)
- (6) Unhook the power monitor receiver P.C. board holder from the catch. (See Photo 4.)
- (7) Open the rear cover of the power monitor receiver P.C. board holder and pull out the power monitor receiver P.C. board.
- (8) Open the switch holder and pull out SW P.C. board.
- (9) Pull the electronic control P.C. board slightly toward you from the electrical box, and disconnect TAB3 and all the connectors on the electronic control P.C. board. (LD101 and LD105 are direct-mounted to the electronic control P.C. board.)
- (10) Pull out the electronic control P.C. board from the electrical box.
- (11) Remove the ground wire connected to the heat exchanger from the electrical box. (See Photo 4.)
- (12) Unhook the catches of the electrical box, and pull out the electrical box.
- (13) Remove the screws of the terminal block cover, and then the terminal block cover and the terminal block holder. (See Photo 2.)
- (14) Remove the terminal block by sliding it.

3. Removing the electrical box

- (1) Remove the horizontal vane, the panel (Refer to 1.) and the corner box.
- (2) Remove the screw of V.A. clamp, and then the indoor/outdoor connecting wire. (See Photo 2.)
- (3) Remove the switch holder and the electrical cover. (See Photo 3.)
- (4) Remove the ground wire connected to the heat exchanger from the electrical box. (See Photo 4.)
- (5) Disconnect the following connectors on the electronic control P.C. board; the fan motor connector <CN211>, the indoor coil thermistor connector <CN112>, the vane motor connector <CN151>, the connector of the interlock switch (Fan) of the horizontal vane <CN1R1>.
- (6) Unhook the catches of the electrical box, and pull out the electrical box.

PHOTOS

Photo 2

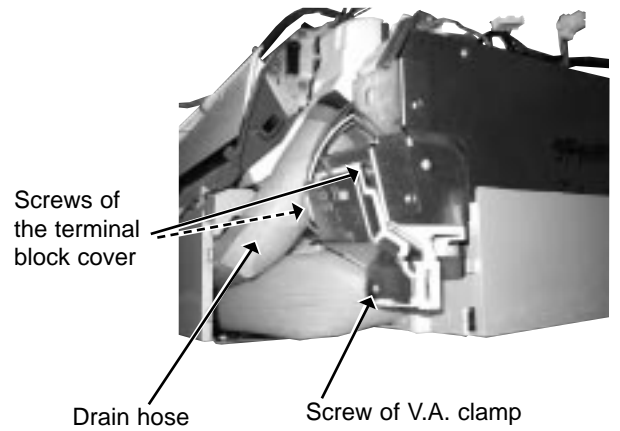

Photo 3

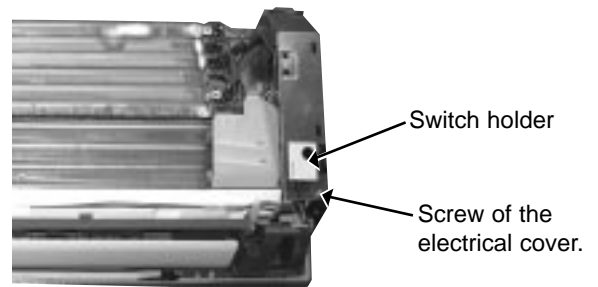
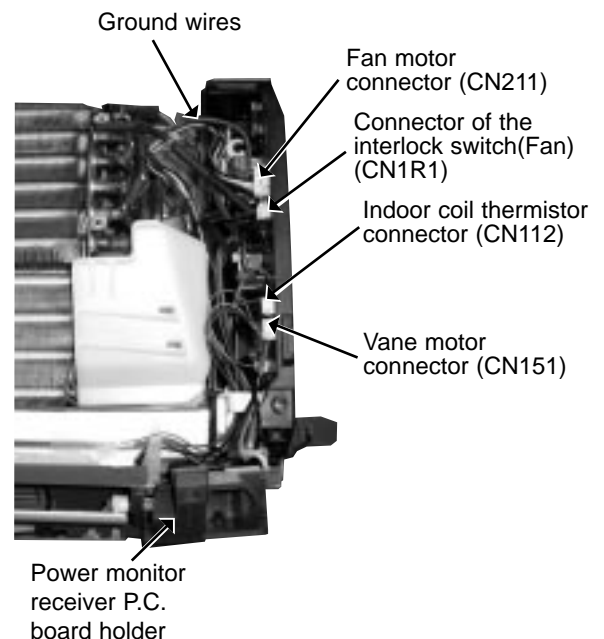

Photo 4



OPERATING PROCEDURE

PHOTOS

4. Removing the horizontal vane motor unit

- (1) Remove the horizontal vane and the panel. (Refer to 1.)
- (2) Remove the screws of the horizontal vane motor unit, and pull out the horizontal vane motor unit. (See Photo 5.)
- (3) Disconnect the connector from the horizontal vane motor unit.

Photo 5

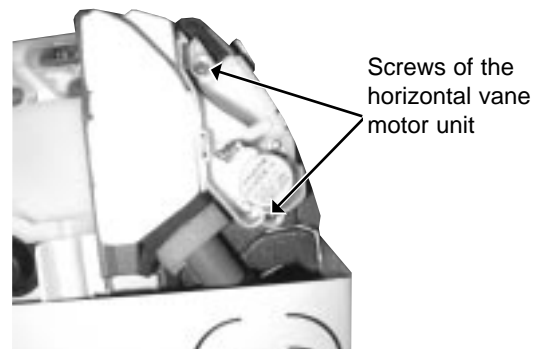

5. Removing the indoor fan motor and the line flow fan

- (1) Remove the horizontal vane, the panel (Refer to 1.) and the corner box.
- (2) Remove the switch holder and the electrical box. (Refer to 3.)
- (3) Pull out the drain hose from the nozzle assembly, and remove the nozzle assembly.
- (4) Remove the screws fixing the motor bed. (See Photo 6.)
- (5) Loosen the screw fixing the line flow fan. (See Photo 7.)
- (6) Remove the motor bed together with fan motor and motor band.
- (7) Release the hooks of the motor band, and remove the motor band then pull out the indoor fan motor.
- (8) Remove the screws fixing the left side of the heat exchanger. (See Photo 8.)
- (9) Lift the heat exchanger, and pull out the line flow fan to the lower-left.

Photo 6

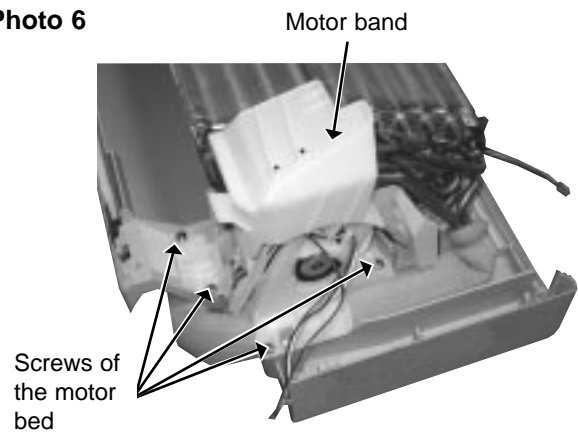

Photo 7

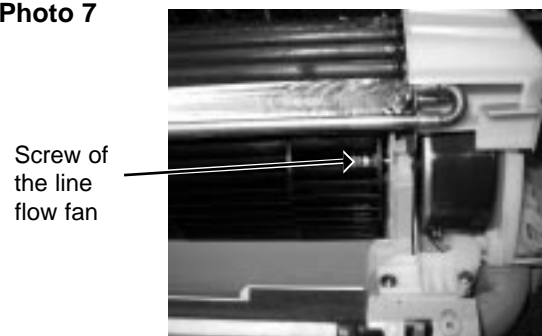
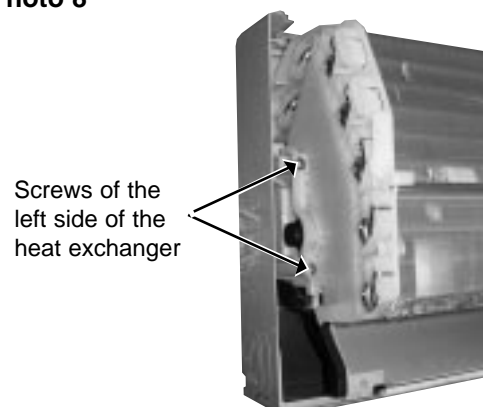

Photo 8



11

RoHS PARTS LIST (RoHS compliant)

MSZ-GB50VA

11-1. INDOOR UNIT STRUCTURAL PARTS

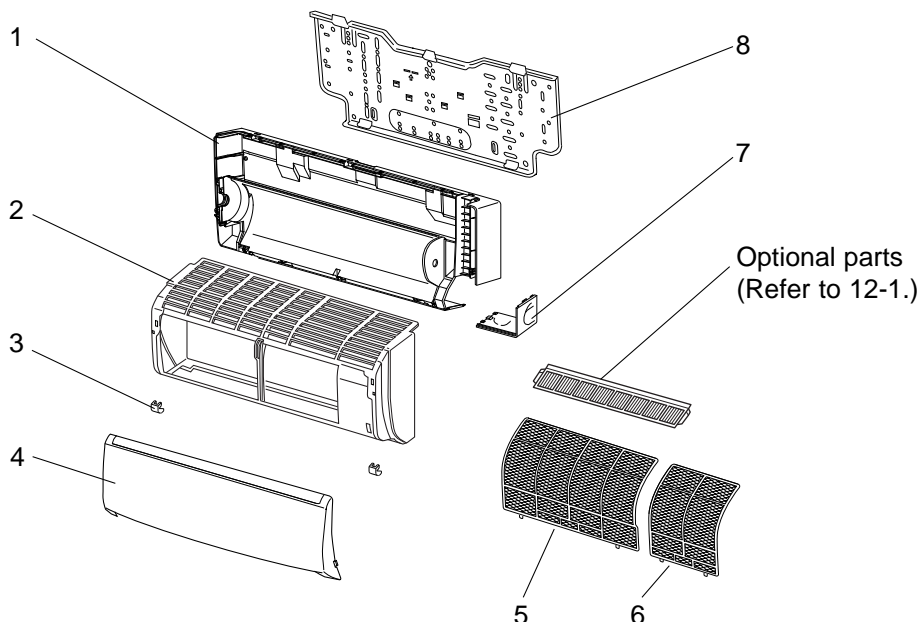

11-2. ACCESSORY AND REMOTE CONTROLLER

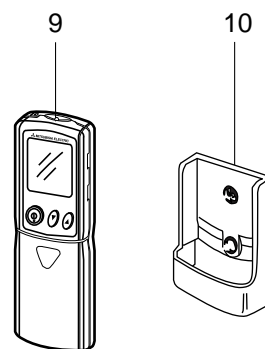

11-1. INDOOR UNIT STRUCTURAL PARTS

No.	RoHS	Part No.	Part name	Symbol in Wiring Diagram	Q'ty/unit	Remarks
					MSZ-GB50VA-	
					E1	
1	G	E12 A32 234	BOX		1	
2	G	E12 915 000	PANEL ASSEMBLY		1	Including No.3,4
3	G	E12 913 067	SCREW CAP		2	2PCS/SET
4	G	E12 915 010	FRONT PANEL		1	
5	G	E12 915 100	CATECHIN AIR FILTER (LEFT)		1	
6	G	E12 916 100	CATECHIN AIR FILTER (RIGHT)		1	
7	G	E12 A32 975	CORNER BOX (RIGHT)		1	
8	G	E12 913 970	INSTALLATION PLATE		1	

11-2. ACCESSORY AND REMOTE CONTROLLER

9	G	E12 915 426	REMOTE CONTROLLER		1	KM05B
10	G	E12 527 083	REMOTE CONTROLLER HOLDER		1	

RoHS PARTS LIST (RoHS compliant)

MSZ-GB50VA

11-3. INDOOR UNIT ELECTRICAL PARTS AND FUNCTIONAL PARTS

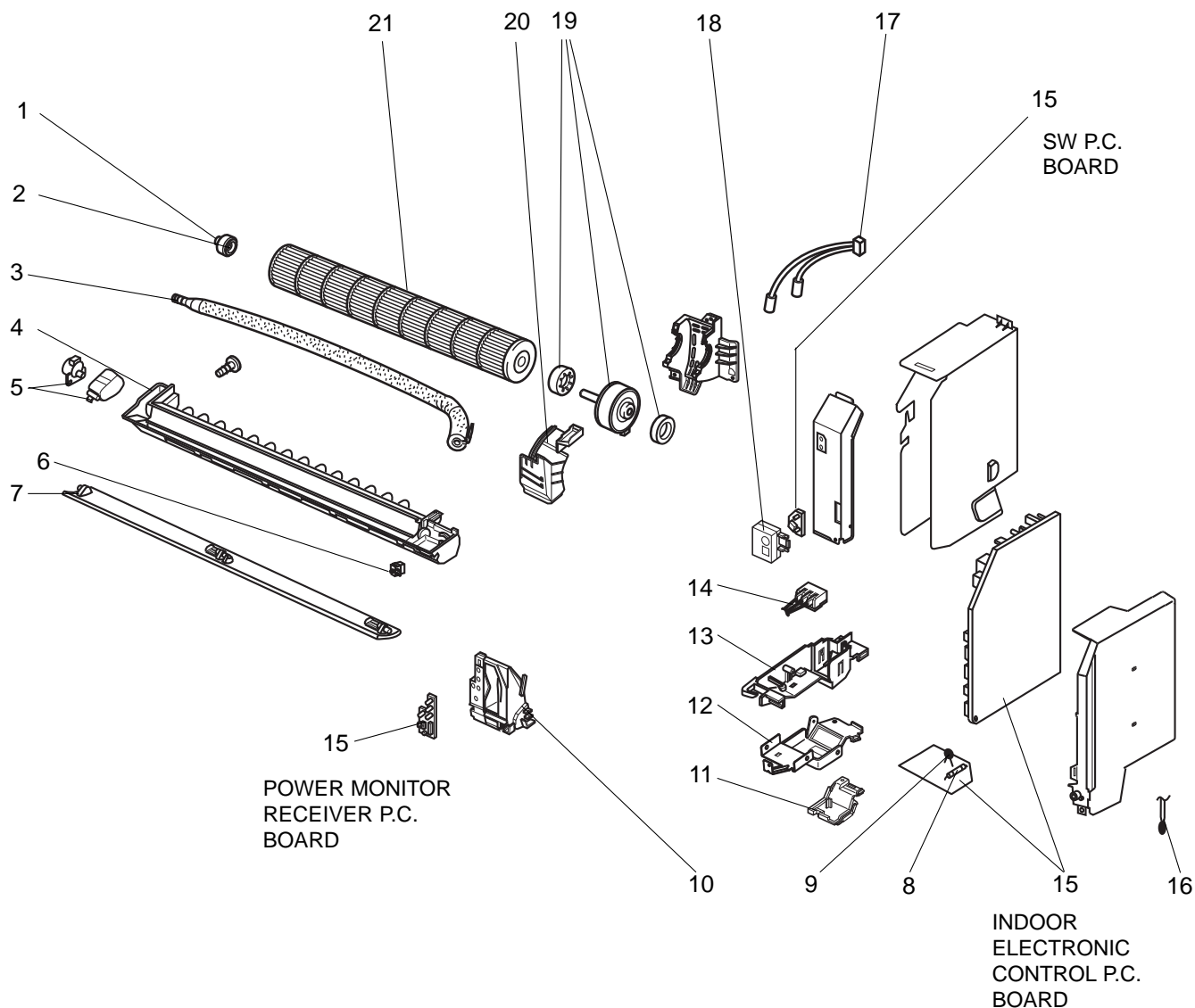

11-4. INDOOR UNIT HEAT EXCHANGER

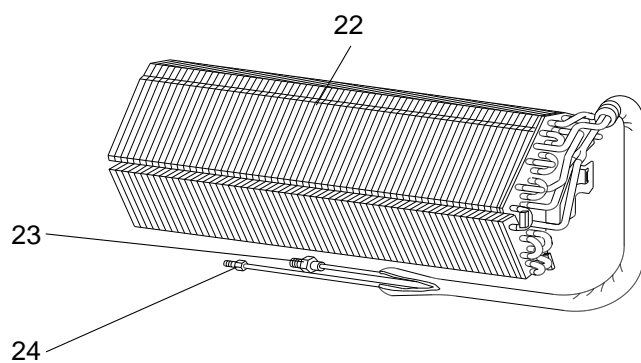

RoHS PARTS LIST (RoHS compliant)

11-3. INDOOR UNIT ELECTRICAL PARTS AND FUNCTIONAL PARTS

No.	RoHS	Part No.	Part name	Symbol in Wiring Diagram	Q'ty/unit	Remarks
					MSZ-GB50VA- E1	
1	G	E12 751 509	BEARING MOUNT		1	
2	G	E12 001 504	SLEEVE BEARING		1	
3	G	E12 897 702	DRAIN HOSE		1	
4	G	E12 A88 235	NOZZLE ASSEMBLY		1	
5	G	E12 897 303	VANE MOTOR UNIT (HORIZONTAL)	MV	1	UP & DOWN
6	G	E12 897 316	INTERLOCK SWITCH(FAN)		1	
7	G	E12 913 040	HORIZONTAL VANE		1	
8	G	E12 A49 382	FUSE	F11	1	T3.15AL 250V
9	G	E12 661 385	VARISTOR	NR11	1	
10	G	E12 915 095	POWER MONITOR RECEIVER P.C. BOARD HOLDER		1	
11	G	E12 897 784	V.A. CLAMP		1	
12	G	E12 897 780	TERMINAL BLOCK COVER		1	
13	G	E12 897 779	TERMINAL BLOCK HOLDER		1	
14	G	E12 913 375	TERMINAL BLOCK	TB	1	
15	G	E12 A88 452	ELECTRONIC CONTROL P.C. BOARD *1		1	AUTO RESTART
16	G	E12 897 308	ROOM TEMPERATURE THERMISTOR	RT11	1	
17	G	E12 A56 307	INDOOR COIL THERMISTOR	RT12, RT13	1	
18	G	E12 915 782	SWITCH HOLDER		1	
19	G	E12 915 300	INDOOR FAN MOTOR *2	MF	1	RC0J30- □ □
20	G	E12 897 333	MOTOR BAND		1	
21	G	E12 897 302	LINE FLOW FAN		1	

*1 Including SW P.C. BOARD and POWER MONITOR RECEIVER P.C. BOARD

*2 Including FAN MOTOR RUBBER MOUNT (2 PCS/SET)

11-4. INDOOR UNIT HEAT EXCHANGER

22	G	E12 A88 620	INDOOR HEAT EXCHANGER		1	
23	G	E12 155 666	UNION (GAS)		1	φ12.7
24	G	E12 138 667	UNION (LIQUID)		1	φ6.35

12-1. AIR CLEANING FILTER (ANTI-ALLERGY ENZYME FILTER)

- AIR CLEANING FILTER removes fine dust of 0.01 micron from air by means of static electricity.
- Normal life of AIR CLEANING FILTER is 1 year.
If AIR CLEANING FILTER is to be washed, soak AIR CLEANING FILTER in water (when showing dirt, in lukewarm water) and rinse it delicately, without removing the filter from the frame about once every 3 months.
- Clogged AIR CLEANING FILTER may reduce the air conditioner capacity or cause frost on the air outlet.
- Do not remove or attach AIR CLEANING FILTER during unit operation.

Model	Part No.
MSZ-GB50VA - E1	MAC-415FT-E

Replacement of the air cleaning filter

- (1) Remove the catechin air filter(left one)
The air cleaning filter cannot be attached to the right side catechin air filter.

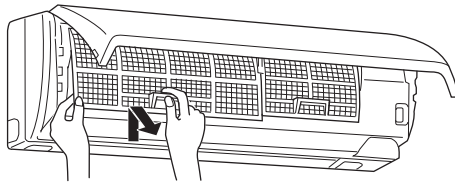

- (2) Remove the air cleaning filter(Blue bellows type) from the catechin air filter.

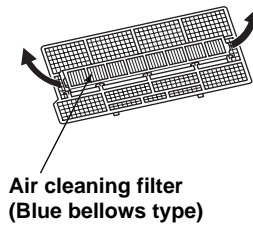

12-2. QUICK CLEAN KIT

- You can sweep the surface of heat exchanger if you install the special-made brush to your vacuum cleaner.

Model	Part No.	
MSZ-GB50VA - E1	MAC-093SS-E	

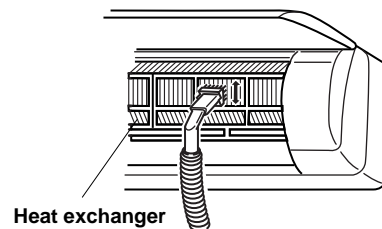



HEAD OFFICE: TOKYO BLDG., 2-7-3, MARUNOUCHI, CHIYODA-KU, TOKYO 100-8310, JAPAN

© Copyright 2006 MITSUBISHI ELECTRIC ENGINEERING CO.,LTD

Distributed in Mar. 2006. No. OB454 6

Made in Japan

New publication, effective Mar. 2006
Specifications subject to change without notice.